

## T 自动反冲洗过滤系统 T Automatic Self-Clean Filtration System

- T 系列是由多个 T 型 2 寸或 3 寸叠片式自动反冲洗过滤器、2 寸或 3 寸反冲洗阀、控制器等组成的高度集成自动清洗过滤系统。系统安装简单，运行高效。适用于首部或二级自动过滤系统，可有效过滤水源中的各类悬浮杂质。
- 流量范围：40-180m<sup>3</sup>/h
- T series is a highly integrated self-cleaning filter system which is combined by several 2" or 3" automatic backflush self-cleaning disc filter, 2" or 3" backwash hydraulic valve, controller etc.. It could be installed easily and work efficiency. Suitable for head or secondary filtration system to filter the water containing various suspended contaminants.
- Flowing Rate: 40-180m<sup>3</sup>/h



### 特点 Features:

- 操作简单 - 控制系统为中 / 英文界面，设置简单易操作。
- 节省人力 - 可全自动反冲洗同时系统稳定可靠，无需人工频繁维护。
- 节水节能 - 低水压低流量反冲洗设计，减少水电损耗。
- 可靠耐用 - 采用优质工程塑料制造，耐化学腐蚀，抗 UV 耐老化。
- Easy Operation: The control system is the Chinese / English interface, with simple and easy to operate.
- Saving manual labour: Program setting automatic backwash, less manual maintenance requirement.
- Saving Water and Energy: Maximum filtration efficiency based on minimum backflushing pressure required.
- Reliable and durable: Produced by excellent raw material which is of corrosion, chemical and UV resistant.

### 技术参数 Technical Data:

- 最大工作压力 :10 Bar (145 Psi)
- 最小反冲洗压力 :1.3 Bar (18 Psi)
- 每单元最小反冲流量 :7m<sup>3</sup>/h (31 gpm)
- Maximum Pressure: 10 Bar (145 Psi)
- Minimum Backflushing Pressure: 1.3 Bar (18 Psi)
- Minimum Backflushing Flow Rate of each unit Filter: 7m<sup>3</sup>/h (31 gpm)

货号 Item No.	单元尺寸 Size of Filter	单元数量 Number of Filter	管道尺寸 Manifold Dia	最大流量 Max Flow		连接方式 Connection	控制单元 Control Unit
				m <sup>3</sup> /h	gpm		
T202-3	2"	2	3" (Dn80)	40	176	法兰 /Flange	12VDC Latch/10Unit
T203-3	2"	3	3"(Dn80)	60	264	法兰 /Flange	
T204-4	2"	4	4"(Dn100)	80	352	法兰 /Flange	
T302-4	3"	2	4"(Dn100)	60	264	法兰 /Flange	
T303-4	3"	3	4"(Dn100)	90	393	法兰 /Flange	
T304-6	3"	4	6"(Dn150)	120	524	法兰 /Flange	
T305-6	3"	5	6"(Dn150)	150	655	法兰 /Flange	
T306-6	3"	6	6"(Dn150)	180	786	法兰 /Flange	

**工作原理 Technology:**

- 过滤状态：控制器控制反冲洗阀开关方向使过滤器进入过滤状态：水流先后通过系统进水管、反冲洗阀、过滤器进水口进入过滤器，水中杂质经叠片过滤后，清水从过滤器出水口流到系统出水管。
- Filtration Process: The controller controls the direction of the backwash valve to make the filter enter the filtration stage: The source water enters the filter passing through the system inlet pipe, backwash valve, and filter inlet one after another. Then the dirt stopped by disc and clean water pass through filter outlet to system outlet pipe.
- 冲洗状态：控制器检测到系统进、出水口压差大于设定值后控制反冲洗阀改变开关方向，从而使该过滤器进入冲洗状态：经其他过滤器过滤后的清水经系统出水管从该过滤器出水口进入并冲洗叠片后，污水通过过滤器进水口、反冲洗阀，排出到系统污水管。
- Backflush Process: After the controller detects that the pressure difference between the inlet and outlet is greater than setted value, it controls the backwash valve to change direction, so that the filter enters the flushing stage: The clean water filtered by other filters passes through the system outlet pipe to the filter outlet and flushing the discs, then the dirty water passes through the filter inlet, the backwash valve and discharged to the system sewage pipe.

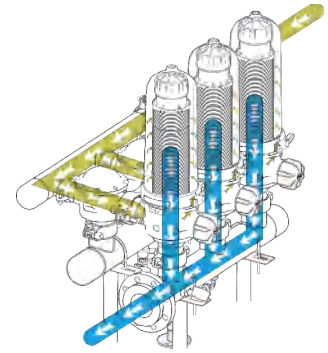

Filtration Process

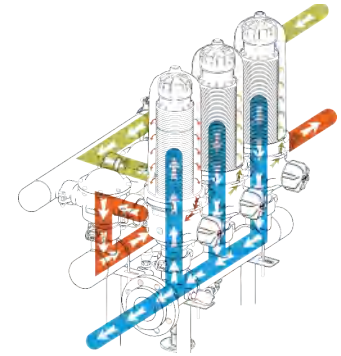

Backflush Process

**尺寸 Dimension:**

货号 Item No.	尺寸 Size (mm)								
	F	E	D	L	W	R	T	S	H
T202-3	272	204	715	698	700	255	495	277	915
T203-3	272	204	930	945	700	265	495	277	915
T204-4	272	204	1065	1220	700	290	515	287	935
T302-4	311	230	644	714	785	267	573	309	1162
T303-4	311	230	829	956	785	267	573	309	1162
T304-6	311	230	1065	1220	785	292	623	334	1212
T305-6	311	230	1419	1553	785	292	623	334	1212
T306-6	311	230	1694	1828	785	292	623	334	1212

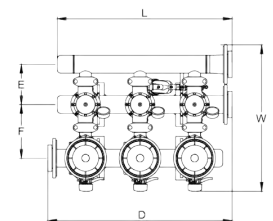
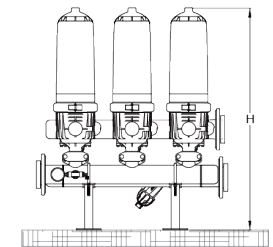
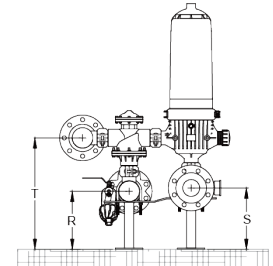

**水头损失表 Head Loss Data:**

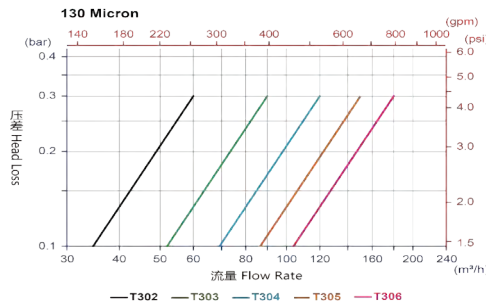
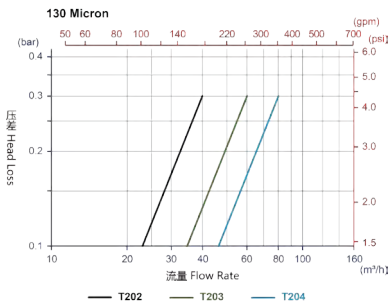

## H 自动反冲洗过滤系统 H Automatic Self-Clean Filtration System

- H 系列是由 3 个以上 3" 或 4 寸 H 型叠片式自动反冲洗过滤器、3" 或 4" 寸反冲洗阀、控制器等组成的高度集成自动清洗过滤系统。系统安装简单，运行高效。
- 适用于首部或二级自动过滤系统，可有效过滤水源中的各类悬浮杂质。  
流量范围：120-600 m<sup>3</sup>/h
- H series is a highly integrated self-cleaning filter system which is combined by several 3" or 4" automatic backflush self-cleaning disc filter, 3" or 4" backwash hydraulic valve, controller etc.. It could be installed easily and work efficiency. Suitable for head or secondary filtration system to filter the water containing various suspended contaminants.
- Flowing Rate: 120-600 m<sup>3</sup>/h



### 特点 Features:

- 操作简单 - 控制系统为中 / 英文界面，设置简单易操作。
- 节省人力 - 可全自动反冲洗同时系统稳定可靠，无需人工频繁维护。
- 节水节能 - 低水压低流量反冲洗设计，减少水电损耗。
- 可靠耐用 - 采用优质工程塑料制造，耐化学腐蚀，抗 UV 耐老化。
- Easy Operation: The control system is the Chinese / English interface, with simple and easy to operate.
- Saving manual labour: Program setting automatic backwash, less manual maintenance requirement.
- Saving Water and Energy: Maximum filtration efficiency based on minimum backflushing pressure required.
- Reliable and durable: Produced by excellent raw material which is of corrosion, chemical and UV resistant.

### 技术参数 Technical Data:

- 最大工作压力 :10 Bar (145 Psi)
- 最小反冲洗压力 :1.6 Bar (23 Psi)
- 每单元最小反冲洗流量 :18m<sup>3</sup>/h (80 gpm)
- Maximum Pressure: 10 Bar (145 Psi)
- Minimum Backflushing Pressure: 1.6 Bar (23 Psi)
- Minimum Backflushing Flow Rate of each unit Filter: 18m<sup>3</sup>/h (80 gpm)

货号 Item No.	单元尺寸 Size of Filter	单元数量 Number of Filter	管道尺寸 Manifold Dia	最大流量 Max Flow		连接方式 Connection	控制单元 Control Unit
				m <sup>3</sup> /h	gpm		
H303-6	3"	3	6" (Dn150)	120	524	法兰 /Flange	12VDC Latch/10Unit
H304-6	3"	4	6"(Dn150)	160	698	法兰 /Flange	
H305-6	3"	5	6"(Dn150)	200	874	法兰 /Flange	
H403-6	4"	3	6" (Dn150)	180	786	法兰 /Flange	
H404-6	4"	4	6"(Dn150)	240	1048	法兰 /Flange	
H405-6	4"	5	6"(Dn150)	300	1310	法兰 /Flange	
H406-8	4"	6	8"(Dn200)	360	1572	法兰 /Flange	
H407-8	4"	7	8"(Dn200)	420	1834	法兰 /Flange	
H408-8	4"	8	8"(Dn200)	480	2096	法兰 /Flange	
H409-10	4"	9	10"(Dn250)	540	2358	法兰 /Flange	
H410-10	4"	10	10"(Dn250)	600	2620	法兰 /Flange	

### 工作原理 Technology:

- 过滤状态: 控制器控制反冲洗阀开关方向使过滤器进入过滤状态: 水流先后通过系统进水管、反冲洗阀、过滤器进水口进入过滤器, 水中杂质经叠片过滤后, 清水从过滤器出水口流到系统出水管。
- Filtration Process: The controller controls the direction of the backwash valve to make the filter enter the filtration stage: The source water enters the filter passing through the system inlet pipe, backwash valve, and filter inlet one after another. Then the dirt is stopped by disc and clean water pass through filter outlet to system outlet pipe.
- 冲洗状态: 控制器检测到系统进、出水口压差大于设定值后控制反冲洗阀改变开关方向, 从而使该过滤器进入冲洗状态: 经其他过滤器过滤后的清水经系统出水管从该过滤器出水口进入并冲洗叠片后, 污水通过过滤器进水口、反冲洗阀, 排出到系统污水管。
- Backflush Process: After the controller detects that the pressure difference between the inlet and outlet is greater than setted value, it controls the backwash valve to change direction, so that the filter enters the flushing stage: The clean water filtered by other filters passes through the system outlet pipe to the filter outlet and flushing the discs, then the dirty water passes through the filter inlet, the backwash valve and discharged to the system sewage pipe.

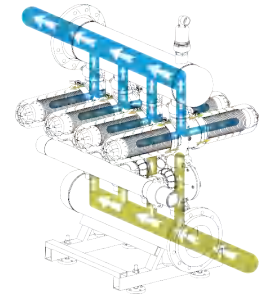

Filtration Process

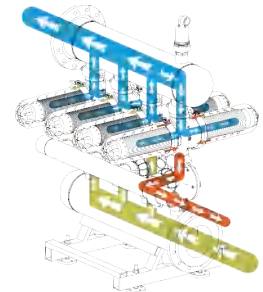

Backflush Process

货号 Item No.	尺寸 Size (mm)								
	F	E	D	L	W	R	T	S	H
H303-6	860	300	930	1040	975	565	300	1170	1670
H304-6	860	300	1145	1285	975	565	300	1170	1670
H305-6	860	300	1420	1560	975	565	300	1170	1670
H403-6	888	306	930	1040	1220	573	300	1188	1690
H404-6	888	306	1145	1285	1220	573	300	1188	1690
H405-6	888	306	1420	1560	1220	573	300	1188	1690
T406-8	928	306	1745	1850	1220	613	320	1248	1770
H407-8	928	306	2020	2125	1220	613	320	1248	1770
H408-8	928	306	2295	2400	1220	613	320	1248	1770
H409-10	978	306	2604	2695	1220	668	350	1328	1875
H410-10	978	306	3029	3120	1220	668	350	1328	1875

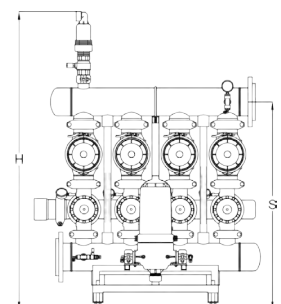
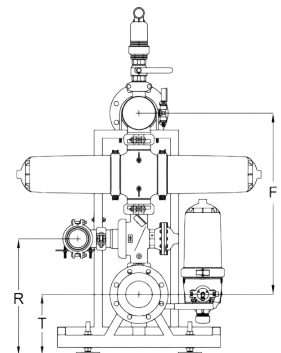
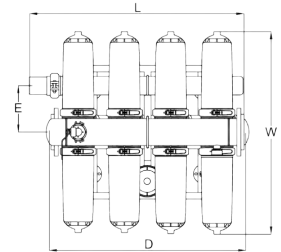

### 水头损失表 Head Loss Data:

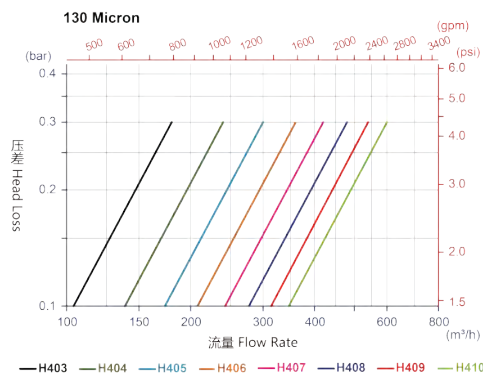
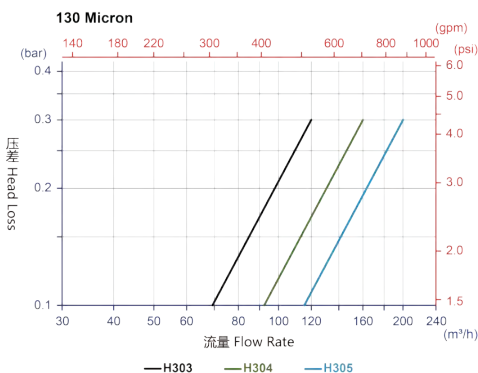

## 自动反冲洗叠片过滤器 Automatic Self-Cleaning Disc Filter

- 本系列过滤器为叠片式自动反冲洗过滤器，适用于首部或二级自动过滤系统，可有效过滤水源中的各类悬浮杂质。过滤性能稳定、高效，相比普通叠片过滤器，其具有反冲洗功能，大幅减少系统维护频率，节省人工，提高系统运行效率。
- This filter is automatic backflush self-cleaning disc filter, to be installed on head or secondary filtration system to filter the water containing various suspended contaminants. It is much more stable and efficient than manual disc filter by the auto back-wash which could reduce the maintenance frequency to save labor and improve the efficiency of system.



### 特点 Features:

- 节水节能 - 可低水压低流量反冲洗设计，减少水电损耗。
- 可靠耐用 - 采用优质工程塑料制造，耐化学腐蚀，抗 UV 耐老化。
- 高效过滤 - 过滤面积大，水头损失小；离心式进水设计，降低反冲洗频次。
- 低频维护 - 凹槽式反冲洗叠片，可实现表面过滤和深层过滤，自动反冲洗无需人工频繁维护。
- Highly Efficient Filtration: Less head loss and backflush frequency by large filtration area size and centrifugal water inlet.
- Saving Water and Energy: Maximum filtration efficiency based on minimum backflushing pressure required.
- Reliable and durable: Produced by excellent raw material which is of corrosion, chemical and UV resistant.
- Less Maintenance Effort: Less manual maintenance requirement, benefit from the enhanced and grooved autoflush disc which could be surface and depth filtration.



### 应用范围 Application:

- 农业灌溉系统的初级或者二次过滤系统。
- 工业循环用水的过滤系统。
- 污水处理的过滤系统。
- Primary or secondary filtration system for agriculture irrigation system.
- Filtration system for industrial circulating water.
- Filtration system for sewage treatment.

### 技术参数 Technical Data:

- 最高工作温度：60°C
- 连接方式：卡箍链接
- 最大工作压力：10 Bar (145 Psi)
- Maximum Working Temperature: 60°C
- End Connections: Grooved
- Maximum Pressure: 10 Bar (145 Psi)

尺寸 Size	单个过滤器最小反冲洗压力 Minimum Backflushing Pressure per Filter		单个过滤器最小反冲洗流量 Minimum Backflushing Flow Rate per Filter	
	Bar	Psi	m <sup>3</sup> /h	gpm
2"	1.3	18	7	31
3"	1.5	21	9	40
4"	1.6	23	18	80

产品名称 Product Description	图片 Picture	货号 Item No.	规格 Size	每箱数量 Carton Qty (Pc)
T 型自动反冲洗叠片过滤器 T Automatic Self-Cleaning Disc Filter		T2AD120V	120Mesh 2"Grooved	1
		T3AD120V	120Mesh 3"Grooved	1
H 型自动反冲洗叠片过滤器 H Automatic Self-Cleaning Disc Filter		H3AD120V	120Mesh 3"Grooved	1
		H4AD120V	120Mesh 4"Grooved	1

### 工作原理 Technology:

- 过滤状态: 滤芯上各叠片间被弹簧压紧, 水流从进水口进入再经过离心盘后产生离心效应, 使水中大颗粒重型杂质远离滤芯并集中于过滤器顶部, 其余微型杂质在跟随水流通过叠片滤芯缝隙时被阻挡达到过滤效果, 从而大大增加了过滤效率, 降低冲洗频次。
- Filtration Process: discs are compressed by a pre-loaded spring. The entering water passes through centrifugal structure, then being centrifugal effect flowing. The flowing enforce large contaminants away from discs. The water then passes efficiently through the discs thus small contaminants be trapped.
- 冲洗状态: 水流反方向进入过滤器并冲开弹簧, 滤芯上的各叠片互相散开, 反冲洗水流通过滤芯架的小孔喷射向叠片并带动叠片旋转和颤动, 最终使附着在叠片上的杂质被冲走并从过滤器的排污口排出。
- Backflush Process: water enters the filter from the opposite direction and discs are released after spring elevating. Water are then forced through the nozzles on the spine and jetting forward to discs. At this stage the discs spin freely, loosening the trapped solids which are then flushed out.



Filtration Process



Backflush Process

### 尺寸 Dimension:

		尺寸 (Size)					过滤面积 Filtering Surface		最大流量 Maximum Flow Rate					
		DN	Inch	W (mm)	D (mm)	H (mm)	cm <sup>2</sup>	in <sup>2</sup>	75mesh 200micron		120mesh 130micron		150mesh 100micron	
									m <sup>3</sup> /h	gpm	m <sup>3</sup> /h	gpm	m <sup>3</sup> /h	gpm
50	T 2"	309	220	595	1052	163	22	97	20	88	15	66		
80	T 3"	336	220	727	1492	231	32	139	30	131	20	88		
80	H 3"	336	220	975	2104	326	44	194	40	176	30	132		
100	H 4"	341	220	1200	2984	463	64	278	60	262	40	176		

### 标准过滤精度

### Standard Filtration Grade:

	叠片颜色 Disc Color		过滤精度 Filtration Grade	
		绿色 Green	80mesh 200micron	
		红色 Red	120mesh 130micron	
		橙色 Orange	150mesh 100micron	

### 水头损失表 Head Loss Data:

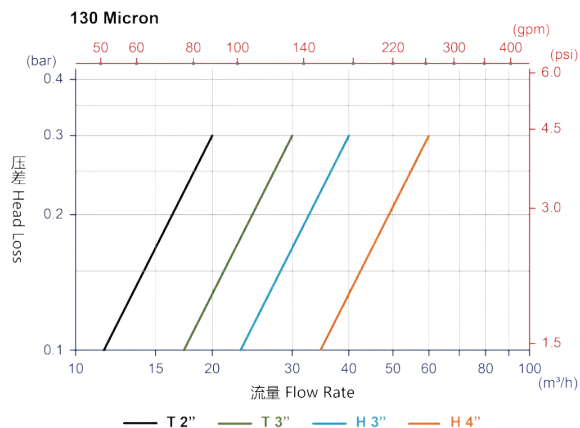

### 材质 Material:

部件 Parts	材质 Material
主体 Housing	尼龙加纤 PA+GF30%
叠片 Discs	聚丙烯 PP
卡箍 Clamp	不锈钢 Stainless Steel
密封圈 Sealing	橡胶 NBR

## 手动叠片过滤器 Manual Disc Filter

- 本系列过滤器为叠片式过滤器，适用于小型过滤系统，可有效过滤水源中的各类悬浮杂质。过滤性能稳定、可靠。
- This series disc filters suit for small filtration system to filter the water containing various suspended contaminants. It supply stable and reliable filtration.



### 特点 Features:

- 经久耐用 - 采用优质工程塑料制造，耐化学腐蚀，抗 UV 耐老化。
- 低频维护 - 凹槽式叠片，过滤面积大，降低清洗频次。
- 可靠性能 - 离心式进水让大颗粒杂质远离叠片，水头损失小，实现高效过滤。
- Highly Durable: Produced by excellent raw material which is of corrosion, chemical and UV resistant.
- Less Maintenance: Less washing frequency benefit from grooved disc with large filtration surface.
- Reliable Performance: Centrifugal inlet water force the particles away from discs, that guarantee the high efficiency filtration with less head loss.

### 应用范围 Application:

- 小型农业灌溉系统的初级或者二次过滤系统。
- 工业循环用水的过滤系统。
- 污水处理的过滤系统。
- Primary or secondary filtration system for small agriculture irrigation system.
- Filtration system for industrial circulating water.
- Filtration system for sewage treatment.

### 技术参数 Technical Data:

- 最高温度：60°C
- 连接方式：外螺纹 / 卡箍
- 最大工作压力：10 Bar (145 Psi)
- Maximum Temperature: 60°C
- End Connections: Male Threaded / Grooved
- Maximum Pressure: 10 Bar (145 Psi)

产品名称 Product Description	图片 Picture	货号 Item No.	规格 Size	每箱数量 Carton Qty (Pc)
T 型手动叠片过滤器 T Type Manual Disc Filter		T2MD120B/N	120Mesh 2"BSP/NPT	1
		T3MD120B/N	120Mesh 3"BSP/NPT	1
H 型手动叠片过滤器 H Type Manual Disc Filter		H3MD120B/N/V/F	120Mesh 3" BSP/ NPT/VIC/Flange	1
		H4MD120B/N/V/F	120Mesh 4" BSP/ NPT/VIC/Flange	1

### 工作原理 Technology:

- 过滤状态: 水流从进水口进入再经过离心盘后产生离心效应, 使水中大颗粒重型杂质远离滤芯并集中于过滤器顶部, 其余微型杂质在跟随水流通过叠片滤芯缝隙时被阻挡达到过滤效果, 从而大大增加了过滤效率, 降低冲洗频次。
- Filtration Process: The entering water passes throughs centrifugal structure, then being centrifugal effect flowing. The flowing enforce large contaminants away from discs. The water then passes efficiently through the discs thus small contaminants be trapped.



Filtration Process

尺寸 (Size)		过滤面积 Filtering Surface		最大流量 Maximum Flow Rate								
				75mesh 200micron		120mesh 130micron		150mesh 100micron				
				m <sup>3</sup> /h	gpm	m <sup>3</sup> /h	gpm	m <sup>3</sup> /h	gpm			
DN	Inch	W (mm)	D (mm)	H (mm)	cm <sup>2</sup>	in <sup>2</sup>						
50	T 2"	309	220	595	1198	186	34	150	30	132	26	114
80	T 3"	336	220	735	1699	263	56	247	50	220	38	167
80	H 3"	336	220	975	2396	371	69	304	60	264	51	225
100	H 4"	341	220	1200	3398	572	113	498	100	440	75	330

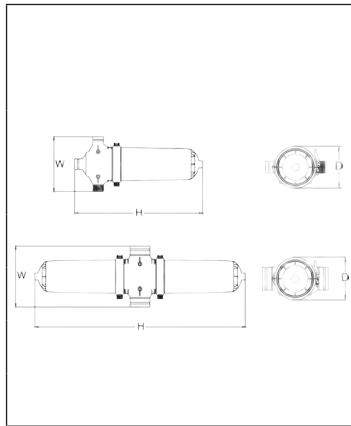

### 标准过滤精度 Standard Filtration Grade:

叠片颜色 Disc Color	过滤精度 Filtration Grade
绿色 Green	80mesh 200micron
红色 Red	120mesh 130micron
橙色 Orange	150mesh 100micron

### 水头损失表 Head Loss Data:

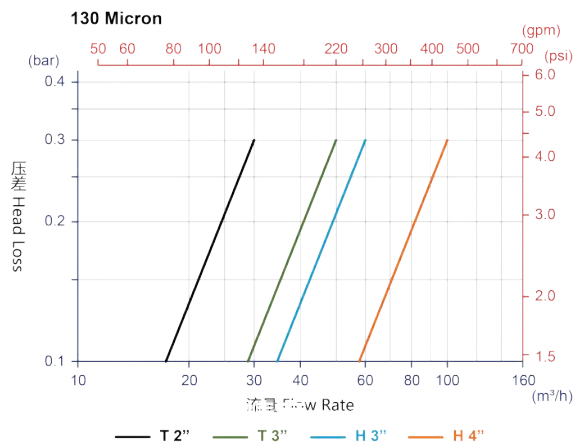

### 材质 Material:

部件 Parts	材质 Material
主体 Housing	聚丙烯加纤 PP+GF15%
叠片 Discs	聚丙烯 PP
卡箍 Clamp	不锈钢 Stainless Steel
密封圈 Sealing	橡胶 NBR





## Y 型小型过滤器 Y Type Micro Filter

### 特点 Features:

- 外壳采用优质复合塑料生产，耐压、抗冲击、坚固耐用。
- 过滤内芯有不锈钢网和叠片两种可供选择，适应不同需要。
- 可过滤不同水质，广泛应用于农业和工业的水处理。
- 多种标准规格可供选择，满足不同需求。
- 易于安装和操作。
- Housings made of very strong plastic, designed to resist great pressure which can be used for long time.
- Two kind of filtration element, stainless screen and disc to be chosen to meet different requirement.
- Can treat different kinds of water source and apply for the water treatment both in Agriculture and Industry.
- Many sizes available can be met widely demands.
- Easy installation and operation.



### 技术参数 Technical Data:

货号 Item No.	螺纹 Size	滤芯 Filter Elements	过滤精度 Filtration Grade	过滤面积 Filtering Surface (cm <sup>2</sup> )	最大压力 Max. Pressure (Bar)	最大流量 Max. Flow (m <sup>3</sup> /h)	尺寸 Dimension (mm)			
							A	B	C	D
1725S120MBT/NT	3/4" BSP/NPT		120 Mesh	95	8	5	125	159	140	82
1732S120MBT/NT	1" BSP/NPT		120 Mesh	95	8	5	134	159	144	82
Y50S120B/N	1-1/2" BSP/NPT		120 Mesh	488	8	20	261	268	280	145
Y63S120B/N	2" BSP/NPT		120 Mesh	488	8	25	268	268	280	145
YB63S120B/N	2" Super BSP/NPT		120 Mesh	802	8	32	301	327	338	171
1725D120MBT/NT	3/4" BSP/NPT		120 Mesh	150	8	4	125	159	140	82
1732D120MBT/NT	1" BSP/NPT		120 Mesh	150	8	4	134	159	144	82
Y50D120B/N	1-1/2" BSP/NPT		120 Mesh	568	8	20	261	268	280	145
Y63D120B/N	2" BSP/NPT		120 Mesh	568	8	25	268	268	280	145
YB63D120B/N	2" Super BSP/NPT		120 Mesh	884	8	32	301	327	338	171

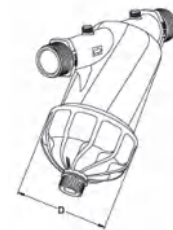
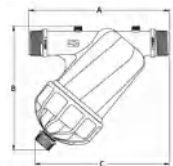

## 过滤器反冲洗阀 Filter Backwash Hydraulic Valve

- 本系列阀门为 T 型两位三通阀，是一款双腔结构的液压驱动隔膜式水力控制阀。
- 本阀门结构设计精良，水力驱动行程短，水流方向改变时平稳顺畅，运行稳定。
- 阀体双腔结构设计，入口水流方向有角式流向和直通流向，可适应各种场景过滤系统安装。
- This valve is T shape 3-way hydraulic valve with double chambered, hydraulically operated and diaphragm actuated which is suitable for various automatic backwashing of filtration systems.
- Benefit from excellent short hydraulic travel structure designed, It could change flow direction smooth.
- With two chambers structure, this valve is available in Angle flow (A) and Straight flow (S). It can be flexibly installed in multiple orientation to adapt various filter system.

### 特点 Features:

- 工作顺畅 - 水力驱动行程短，水流向切换顺畅，有效避免清水与污水混合。
- 可靠耐用 - 双腔结构，所需驱动压力低，有效延长隔膜寿命。
- 耐候性好 - 优质塑料制造，阀体抗腐蚀、耐老化。
- 安装方便 - 角式流向与直通流向两种水流方式适合不同安装场景。
- Double Chambered: low actuation pressure required, extend the lifetime of the diaphragm.
- Durable Performance: Produced by excellent engineered plastic which is of corrosion and UV resistant.
- Reliable Performance: change flow direction smoothly based on short travel hydraulic actuation design to avoid mixing of supply and waste water.
- Easy Installation: two flow direction modes, Angle flow (A) and Straight flow (S), to fit various automatic filtration system.



### 技术参数 Technical Data:

- 连接方式: 卡箍链接
- 工作压力: 0.7-10 Bar
- 最高使用温度: 65°C
- 外压: 工作压力的 85%-100%
- 控制腔工作容量: 2" 为 0.13 升, 3" 为 0.34 升, 4" 为 0.55 升
- End Connections: Grooved
- Operating Pressure: 0.7-10 Bar
- Maximum Temperature: 65°C
- External Operating Pressure: 85%-100% of operating pressure
- Control Chamber Displacement Volume: 0.13L of 2", 0.34L of 3", 0.55L of 4"

### 应用范围 Application:

- 适用于各种自动反冲洗过滤器组: 叠片过滤器, 砂石过滤器, 网式过滤器。
- Installing into multiple type automatic backwash filtration station: disk filters, sand filter, screen filters.

产品名称 Product Description	图片 Picture	货号 Item No.	连接口径 Connecting Dia	规格 Size	每箱数量 Ctn Qty (Pc)
过滤器反冲洗阀, 角式 Filter Backwash Hydraulic Valve, Angle Flow		BHV0150A	2" 卡箍 Grooved	角式 Angle	1
		BHV0180A	3" 卡箍 Grooved	角式 Angle	1
		BHV01100A	4" 卡箍 Grooved	角式 Angle	1
过滤器反冲洗阀, 直通式 Filter Backwash Hydraulic Valve, Straight Flow		BHV0150S	2" 卡箍 Grooved	直通式 Straight	1
		BHV0180S	3" 卡箍 Grooved	直通式 Straight	1
		BHV01100S	4" 卡箍 Grooved	直通式 Straight	1

尺寸 Dimension:

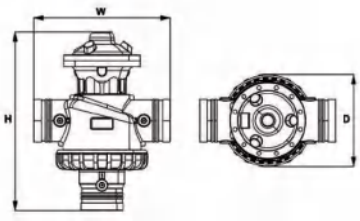
	尺寸 (Size)					阀门流量系数 Flow Rate of Valve							
	DN	Inch	W (mm)	D (mm)	H (mm)	角式流向 Angle Flow				直通式流向 Straight Flow			
						过滤 Filtration		反冲洗 Backwash		过滤 Filtration		反冲洗 Backwash	
						Kv	Cv	Kv	Cv	Kv	Cv	Kv	Cv
50	2"	232	160	274	52	60	48	56	46	53	60	70	
80	3"	287	192	378	110	127	100	115	93	107	122	141	
100	4"	357	260	464	225	260	205	237	190	220	250	290	

工作原理 Operation:

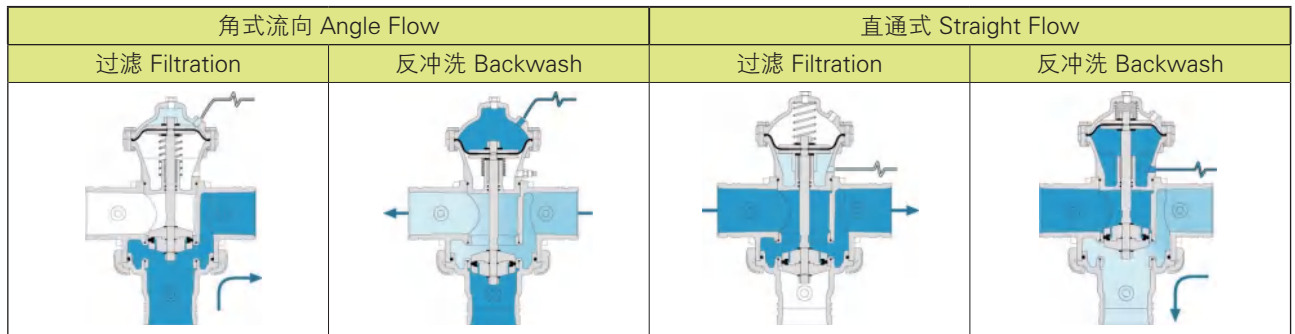

水头损失表 Head Loss Data:

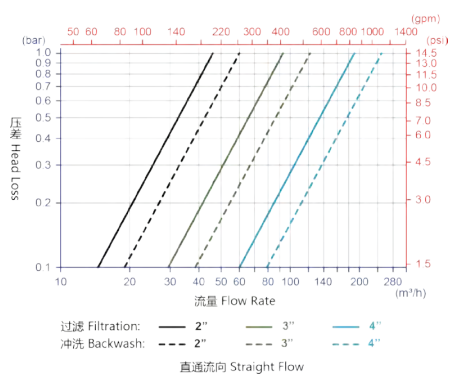
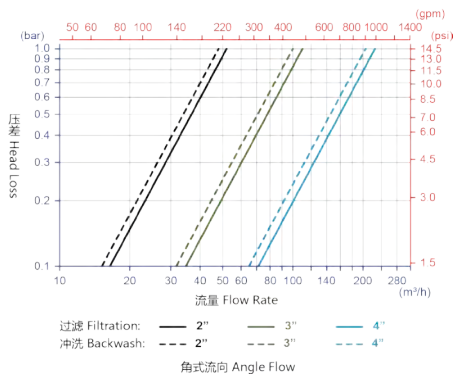

产品结构图 Part List:

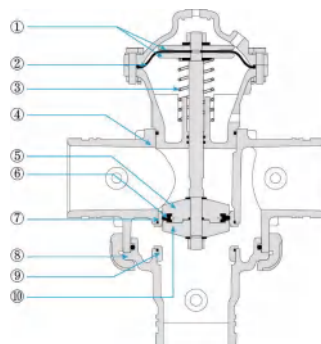

序号 Part	名称 Description
1	隔膜垫片 Diaphragm Washers
2	隔膜 Diaphragm
3	弹簧 Spring
4	阀体 Body
5	阀芯 Plug
6	O型圈 O-Ring
7	阀座 Seat
8	下部接头 Lower Adaptor
9	阀座 Seat
10	阀芯垫片 Plug Washer

## 自动过滤系统控制器 Controller for Automatic Self-Clean Filtration System

FC01 系列是专门为自动过滤系统设计的模块化反冲洗控制器，内置电脑微芯片和程序编辑，通过水压传感器（信息输入）和电磁阀（信息输出）将反冲阀、过滤单元、持压阀等零部件组成自动反冲洗过滤系统，可按照设定程序在线自动轮流清洗每个过滤单元，实现整个系统的过滤杂质自动清理，同时又不间断过滤供水，不影响正常灌溉作业。

FC01 is a modular controller, build-in programmed microchip, designed for automatic backflush filtration system. It combines the backwash valves, filters, pressure sustaining valves etc. to be a automatic backflush filtration system through pressure sensor (input signal) and solenoid valve (output signal). It could control each filter unit to be flushed automatically by turns. Based on this, the filtration system achieves supplying continuously cleaned water to irrigation system while washing filter units in same time. So that irrigation system works nonstop.

### 特点 Features:

- 配有定制的液晶彩色显示屏，显示界面简洁人性化。
- 防水防潮设计，可适合不同工作环境。
- 10 个输出端口，可满足大部分系统过滤单元数量需求。
- 直流型自带 4 个 1# 电池 或 5V DC 电源适配器，安全可靠，防止雷击。
- Equipped with a customized color LCD display which user interface is simple and user-friendly.
- Chinese/English dual language, the program setting is simple and easy to operate.
- Suitable for different working environments benefit from waterproof and moisture-proof design.
- Can meet the number of filter units in most systems by 10 output ports.
- Power Supply is 4 pcs D battery or 5V DC power adapter, which are safe and reliable and prevent lightning strikes.



### 功能 Features:

- 可以设定三种反冲洗启动模式：定时启动、压差启动、手动启动；
- 可以灵活地设置反冲洗时长、反冲洗阀间隔时长、压差检测反应延迟时长；
- 可自动统计反冲洗次数，便于定期维护；
- 可自动检测并显示输出反冲洗阀站的数量；
- 电池电压不足时，屏上将显示低电压报警；
- 可一键恢复出厂时初始设置；
- 自带操作提示，无需复杂操作手册。
- It can be set three flushing mode: by time, by different pressure, by manual.
- It can be flexibly set the flushing time, flushing interval, DP response time etc.
- It can record flushing count automatically, which is convenient for regular maintenance.
- It can automatically detect and display the number of backwash valve stations.
- When the battery voltage is insufficient, a low voltage alarm will be displayed on the screen display.
- The factory default settings can be restored with one key.
- It comes with operation tips, no complicated operation manual is required.



### 技术参数 Technical Data:

- 显示屏：液晶彩屏 3.5"
- 输入电压：5-6VDC
- 输出电压：12VDC 脉冲
- 输入压差范围：0-2.0Bar
- 输出站点：10 个
- 防水等级：IP65
- 工作温度：0-60°C
- Display: 3.5" Colorful LCD
- Input Power: 5-6VDC
- Output Power: 12VDC Latching
- Input DP Range: 0-2.0 Bar (0-29 Psi)
- Output Port: 10 Stations
- Waterproof: IP65
- Working Temperature: 0-60°C

产品名称 Product Description	图片 Picture	货号 Item No.	规格 Size	每箱数量 Carton Qty (Pc)
自动过滤系统控制器 Automatic Filter System Controller		FC01DC10	12VDC / 10Unit	1